

# IDEAL KOKER MODULAIR 450x200 lengte 2,5m

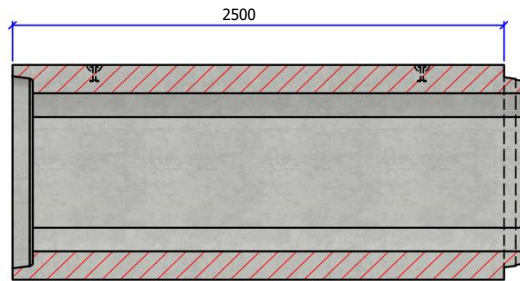

Langssnede

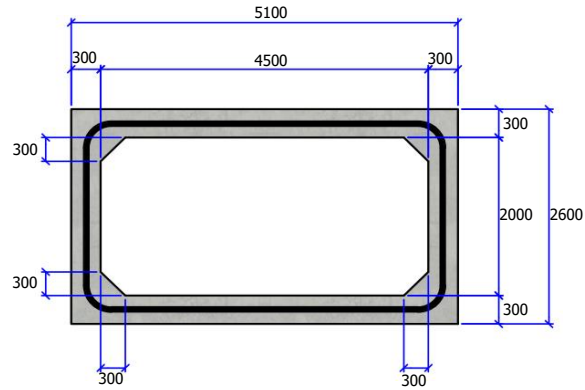

Vooraanzicht



Detail mof/spie

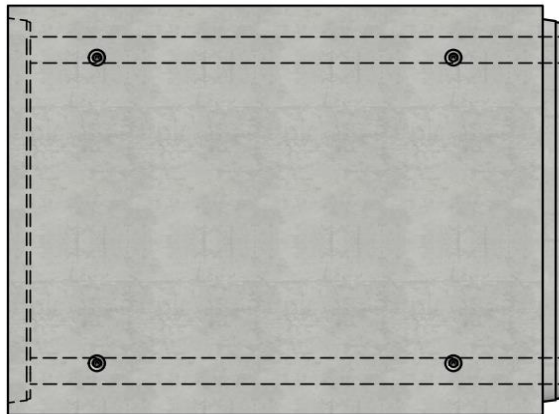

Bovenaanzicht



Belastingsklasse:	C kN/m <sup>2</sup>
Sectie stroomprofiel m <sup>2</sup> :	8,82
Betonsterkteklasse:	C60/75
Omgevingsklasse:	XF4-XC4-XD3-XA3
Werkende lengte mm:	2500
Helling stroomprofiel:	N/A
Voegverbinding:	dichting CK89
Hijsvoorziening:	4 x kogelkopanker 15T
Plaatsingsvoorschrift:	volgens opgave producent
Normering:	conform EN14844
Gewicht kg:	27750

**IDEAL**

Project:	<b>Kokers</b>
Art. nr.:	IDEAL-KM450200W30L2,5M-C
Rev.nr.:	0
REV.Datum:	05/07/2022

