

IDEAL KOKER MODULAIR 350x250 lengte 3m

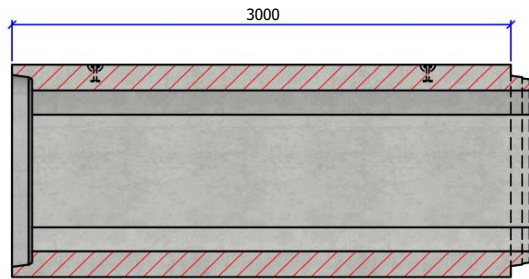

Langssnede

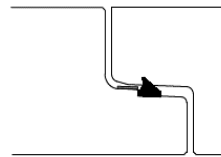

Detail mof/spie

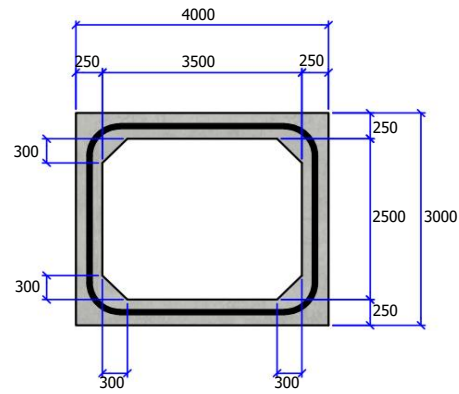

Vooraanzicht

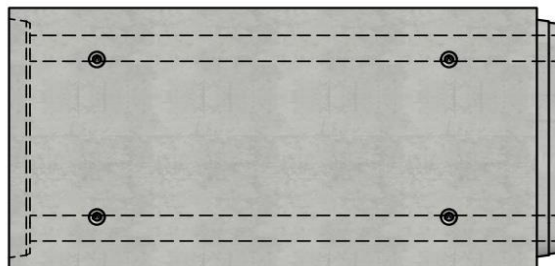

Bovenaanzicht

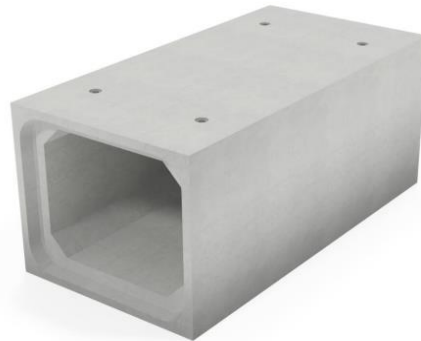

Belastingsklasse:	C kN/m ²
Sectie stroomprofiel m ² :	8,57
Betonsterkteklasse:	C60/75
Omgevingsklasse:	XF4-XC4-XD3-XA3
Werkende lengte mm:	3000
Helling stroomprofiel:	N/A
Voegverbinding:	dichting CK89
Hijsvoorziening:	4 x kogelkopanker 10T
Plaatsingsvoorschrift:	volgens opgave producent
Normering:	conform EN14844
Gewicht kg:	25725

IDEAL

Project:	Kokers	
Art. nr.:	IDEAL-KM350250W25L3M-C	
Rev.nr.:	0	REV.Datum: 05/07/2022

