

IDEAL KOKER MODULAIR 300x300 lengte 1,3m

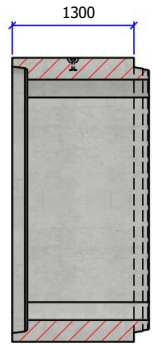

Langssnede

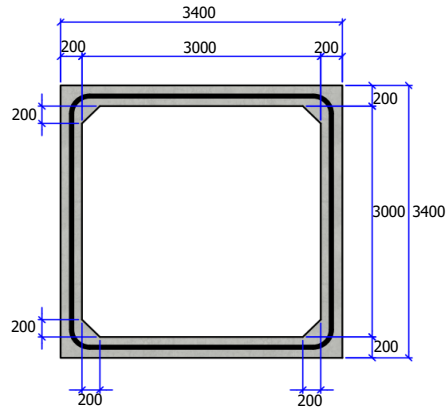

Vooraanzicht

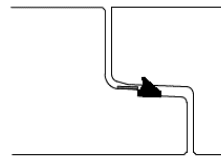

Detail mof/spie

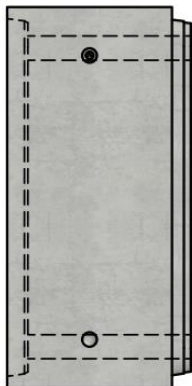

Bovenaanzicht

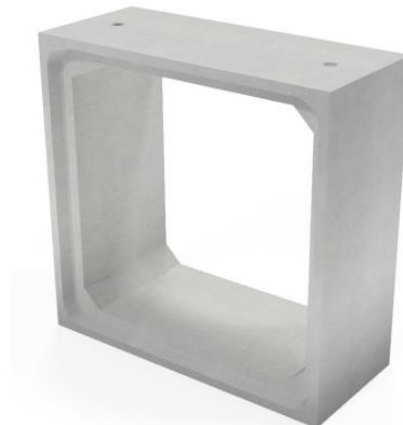

Belastingsklasse:	C kN/m ²
Sectie stroomprofiel m ² :	8,92
Betonsterkteklasse:	C60/75
Omgevingsklasse:	XF4-XC4-XD3-XA3
Werkende lengte mm:	1300
Helling stroomprofiel:	N/A
Voegverbinding:	dichting CK89
Hijsvoorziening:	2 x kogelkopanker 7,5T
Plaatsingsvoorschrift:	volgens opgave producent
Normering:	conform EN14844
Gewicht kg:	8580

IDEAL

Project:	Kokers
Art. nr.:	IDEAL-KM300300W20L1,3M-C
Rev.nr.:	0
REV.Datum:	05/07/2022

