

IDEAL KOKER MODULAIR 300x150 lengte 2,5m

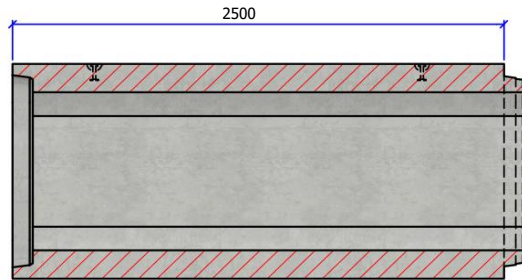

Langssnede

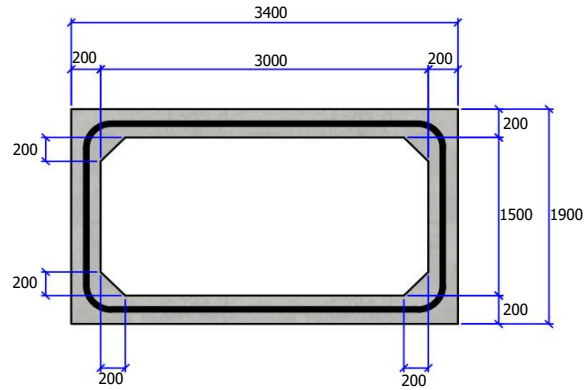

Vooraanzicht

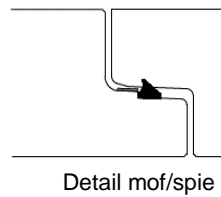

Detail mof/spie

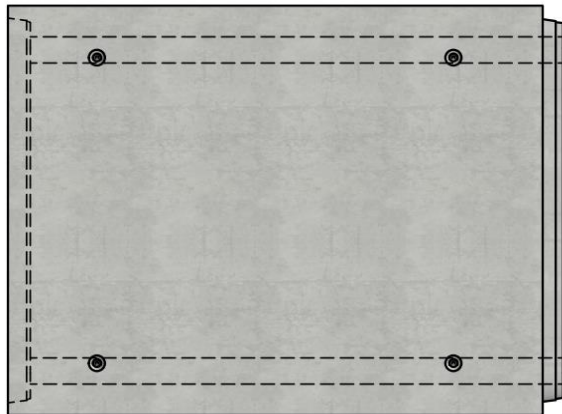

Bovenaanzicht



Belastingsklasse:	C kN/m ²
Sectie stroomprofiel m ² :	4,42
Betonsterkteklasse:	C60/75
Omgevingsklasse:	XF4-XC4-XD3-XA3
Werkende lengte mm:	2500
Helling stroomprofiel:	N/A
Voegverbinding:	dichting CK89
Hijsvoorziening:	4 x kogelkopanker 7,5T
Plaatsingsvoorschrift:	volgens opgave producent
Normering:	conform EN14844
Gewicht kg:	12750

IDEAL

Project:	Kokers	
Art. nr.:	IDEAL-KM300150W20L2,5M-C	
Rev.nr.:	0	REV.Datum: 05/07/2022

