

# IDEAL KOKER 150x60 lengte 3m 100 kN/m<sup>2</sup>

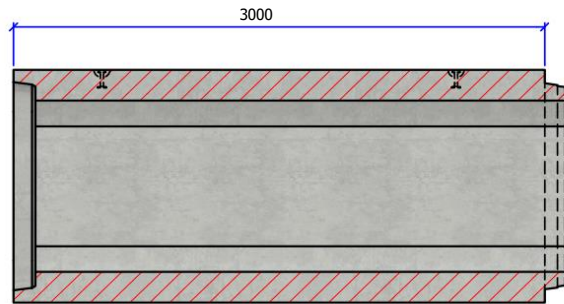

Langssnede

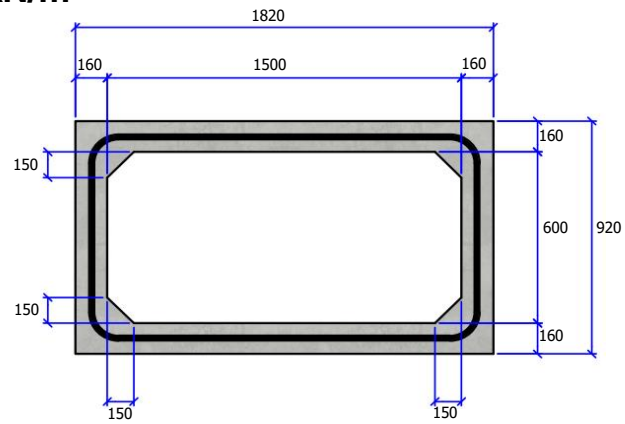

Vooraanzicht

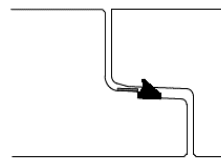

Detail mof/spie

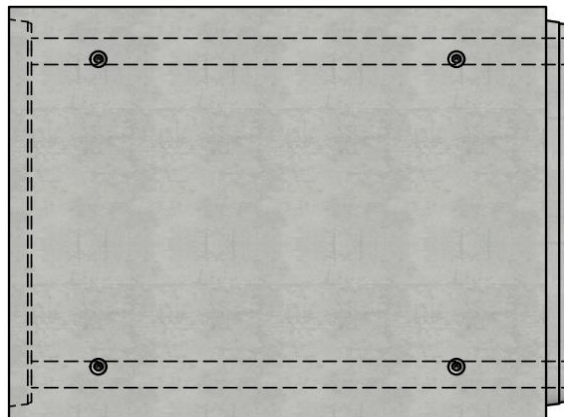

Bovenaanzicht



Belastingsklasse:	100 kN/m <sup>2</sup>
Sectie stroomprofiel m <sup>2</sup> :	0,855
Betonsterkteklasse:	C45/55
Omgevingsklasse:	XF1-XC4-XA3
Werkende lengte mm:	3000
Helling stroomprofiel:	N/A
Voegverbinding:	dichting CK89
Hijsvoorziening:	4 x kogelkopanker 5,0T
Plaatsingsvoorschrift:	volgens opgave producent
Normering:	conform EN14844
Gewicht kg:	6146

# IDEAL

Project:	<b>Kokers</b>	
Art. nr.:	IDEAL-K15060W16L3M100kN	
Rev.nr.:	0	REV.Datum: 05/07/2022

