

IDEAL KOKER 150x125 lengte 3m 100 kN/m² ZOMERLOOP

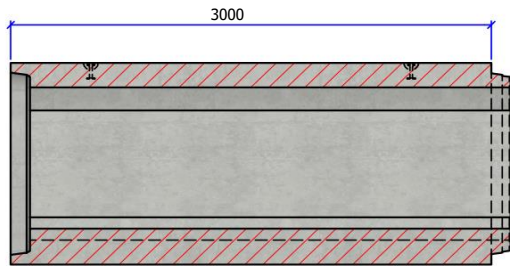

Langssnede

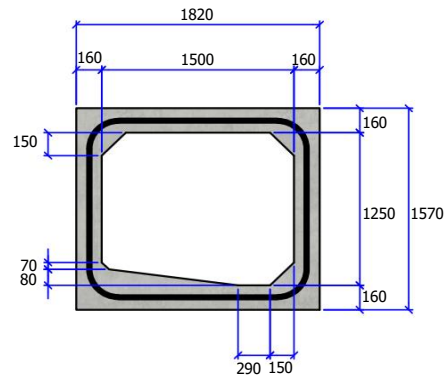

Vooraanzicht

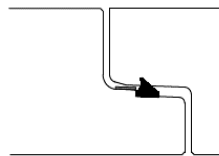

Detail mof/spie

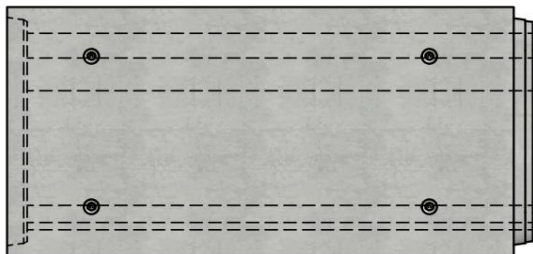

Bovenaanzicht

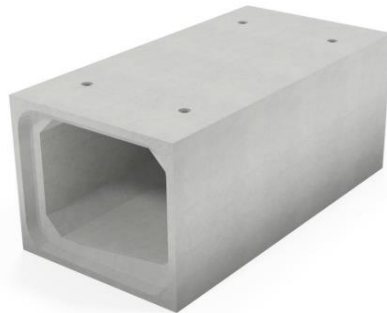

Belastingsklasse:	100 kN/m ²
Sectie stroomprofiel m ² :	1,7904
Betonsterkteklasse:	C45/55
Omgevingsklasse:	XF1-XC4-XA3
Werkende lengte mm:	3000
Helling stroomprofiel:	8%
Voegverbinding:	dichting CK89
Hijsvoorziening:	4 x kogelkopanker 5,0T
Plaatsingsvoorschrift:	volgens opgave producent
Normering:	conform EN14844
Gewicht kg:	8003

IDEAL

Project:	Kokers	
Art. nr.:	IDEAL-K150125W16L3M100kNZ	
Rev.nr.:	0	REV.Datum: 05/07/2022

